

Data Sheet



Article number: 2042516200CR

Description: E+G U-handle GN 425-16-200-CR

Measures

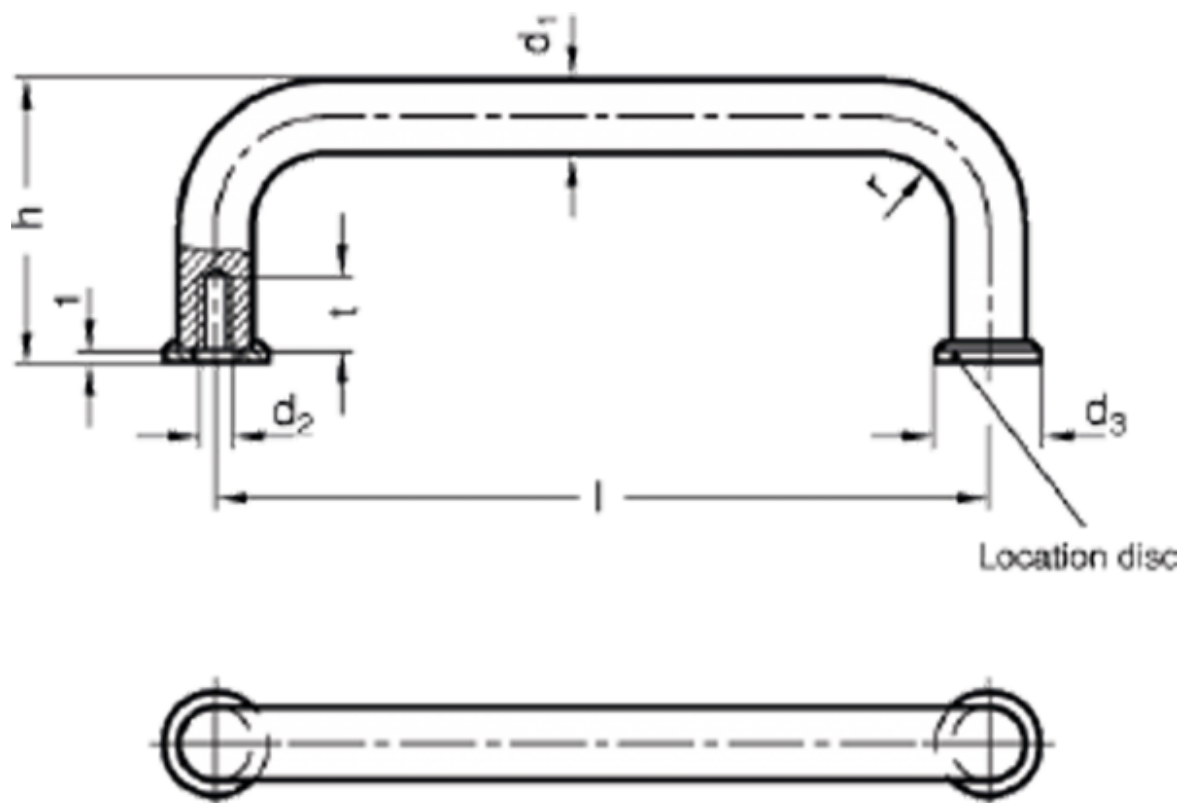

$d_1 = 16$
 $d_2 = M6$
 $d_3 =$
 $h = 59$
 $l = 200$
 $r = 18$
 $t = 12$